

ESS Batteries by Samsung SDI

Top Safety & Reliability Solutions

SAMSUNG SDI 

**Energy Storage System
Business Division**

Headquarters

KOREA 150-20 Gongse-dong, Giheung-gu, Yongin-city, Gyeonggi-do 17084, Korea
TEL +82-31-8006-3281 **E-mail** energy.storage@samsung.com

Local Contacts

GERMANY Reichenbachstrasse 2, 85737 Ismaning, Germany
TEL +49-89-9292-7799(19) **E-mail** sintaek.yim@samsung.com

USA 3655 North 1st Street, San Jose, CA 95134, USA
TEL +1-408-544-4491 **E-mail** eliz.park@samsung.com

CHINA No.788,Mingchuan Rd. Boyan Science & Technology Park.Hefei State Hi-tech Zone.P.R.China.
TEL +86-551-6532-7500 **E-mail** hgleo.ryu@samsung.com

JAPAN (108-0075) Shinagawa Grand Central Tower 9F, 2-16-4, Konan, Minato-ku, Tokyo, Japan
TEL +81-3-6369-6414 **E-mail** m.goto@samsung.com

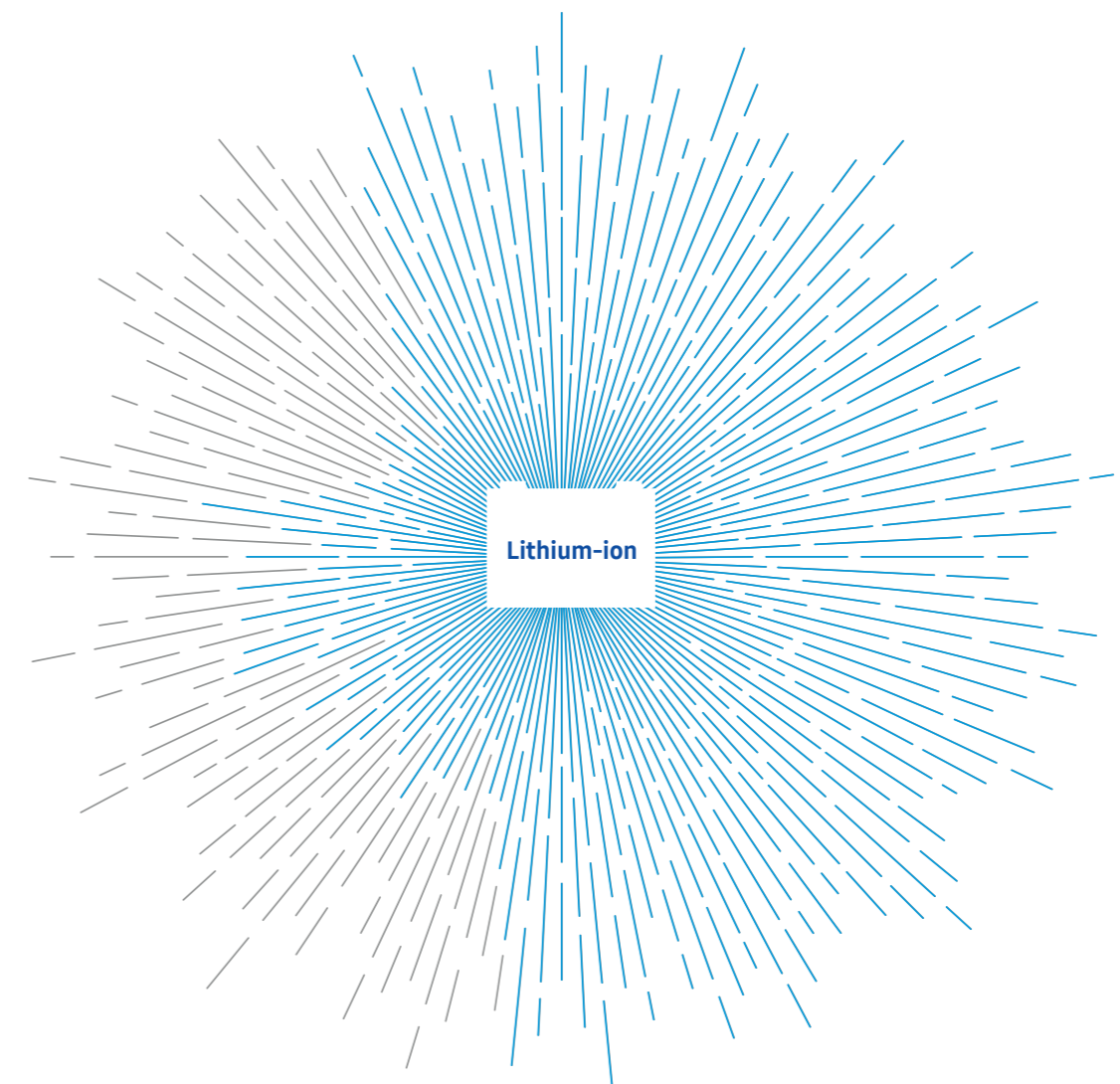

March. 2017

www.samsungsdi.com

© 2017 SAMSUNG SDI Co., Ltd. All right reserved.

SAMSUNG SDI reserves the right to modify the design, packaging, specifications and features shown herein, without prior notice or obligation.

SAMSUNG SDI

SAMSUNG SDI

About Samsung SDI

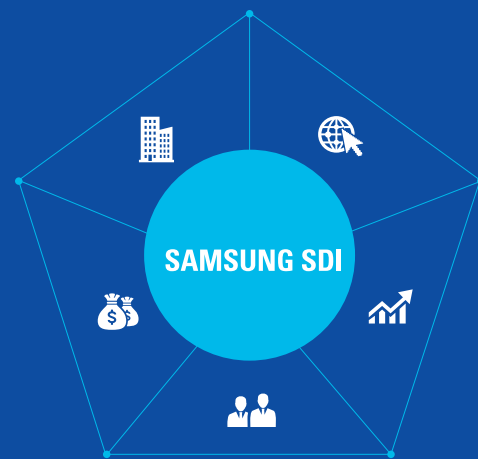

Establishment
1970

Sales Revenue
USD \$4.5B(est.)*

Global Network
28 subsidiaries*

Employees
19,000*

Asset
USD \$12.8B*

* 2016

Creative Energy & Materials Solution Leader

A creative leader in technology on the foundation of continuous improvement and innovation.

Core Value



Business Areas

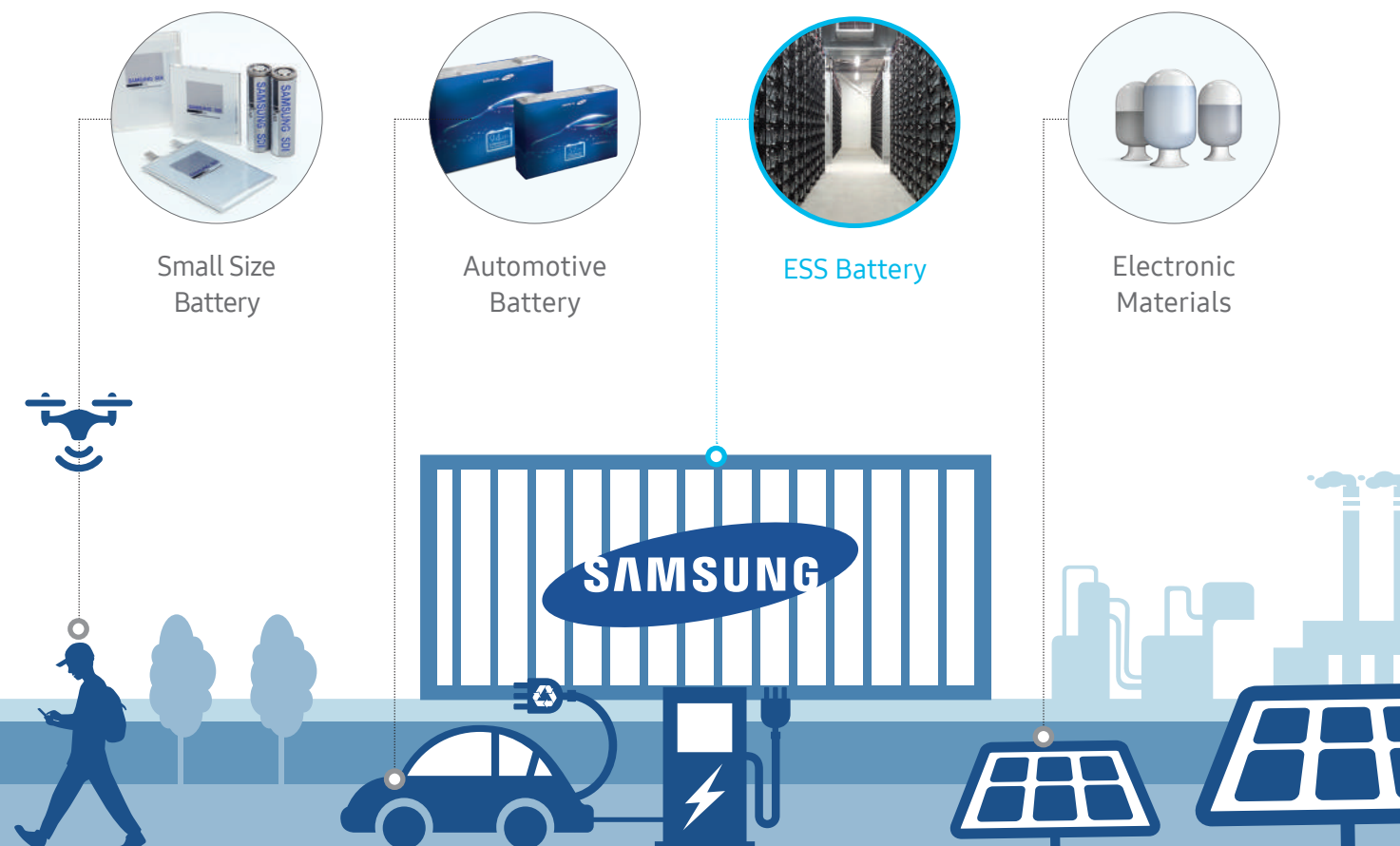

ESS Battery Business

As a specialized manufacturer of lithium-ion batteries, Samsung SDI is leading the growth of the ESS market with our customers.

Business History

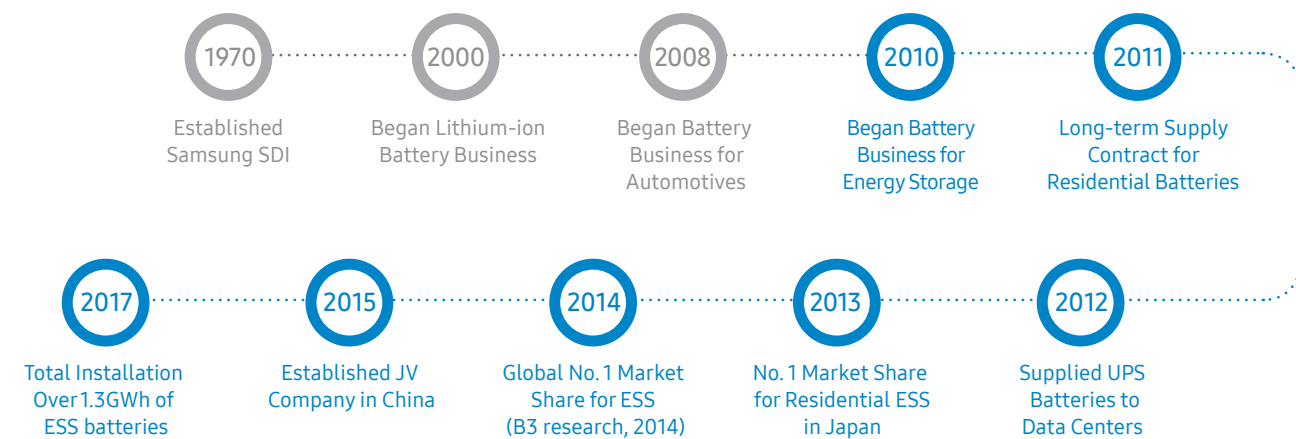

Sales & Production Sites

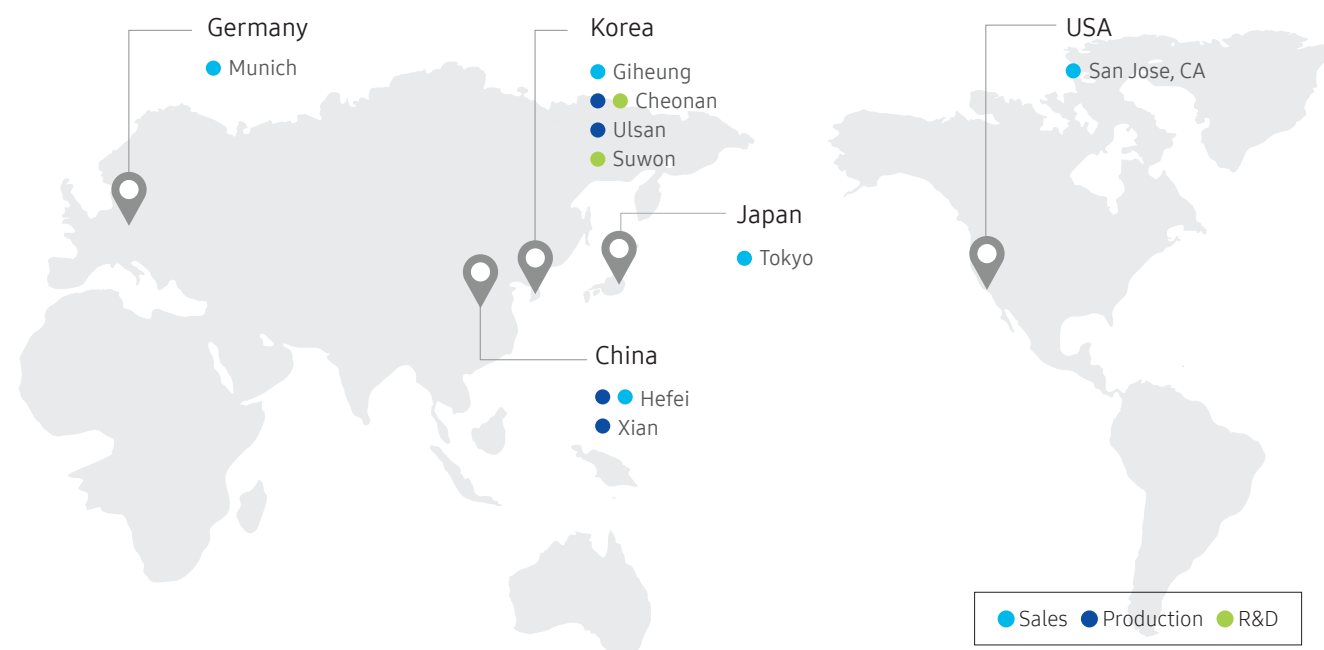

Battery Solutions for ESS

Samsung SDI provides optimal lithium-ion battery solutions ranging from residential to utility-scale ESS.

Applications of ESS

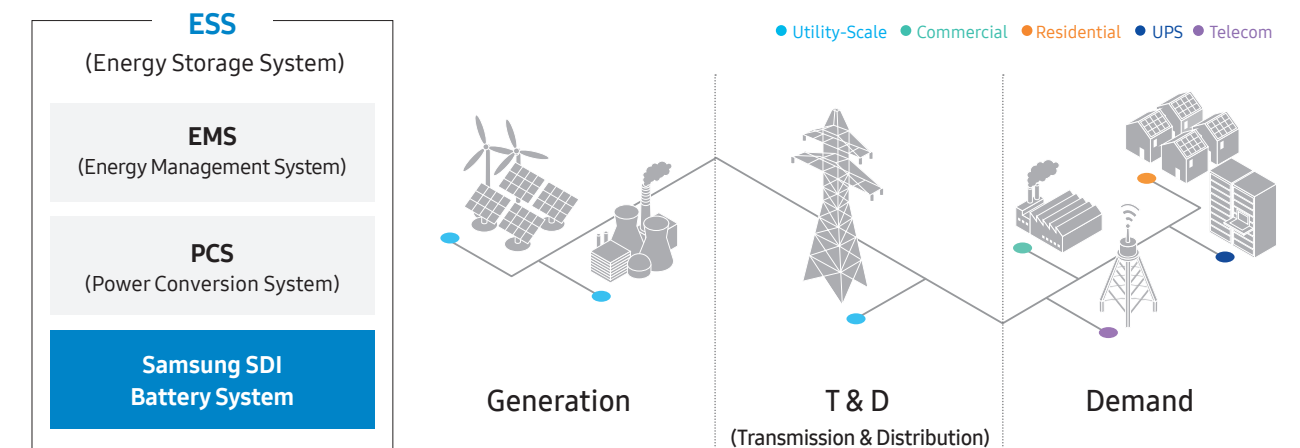

Product Lineup

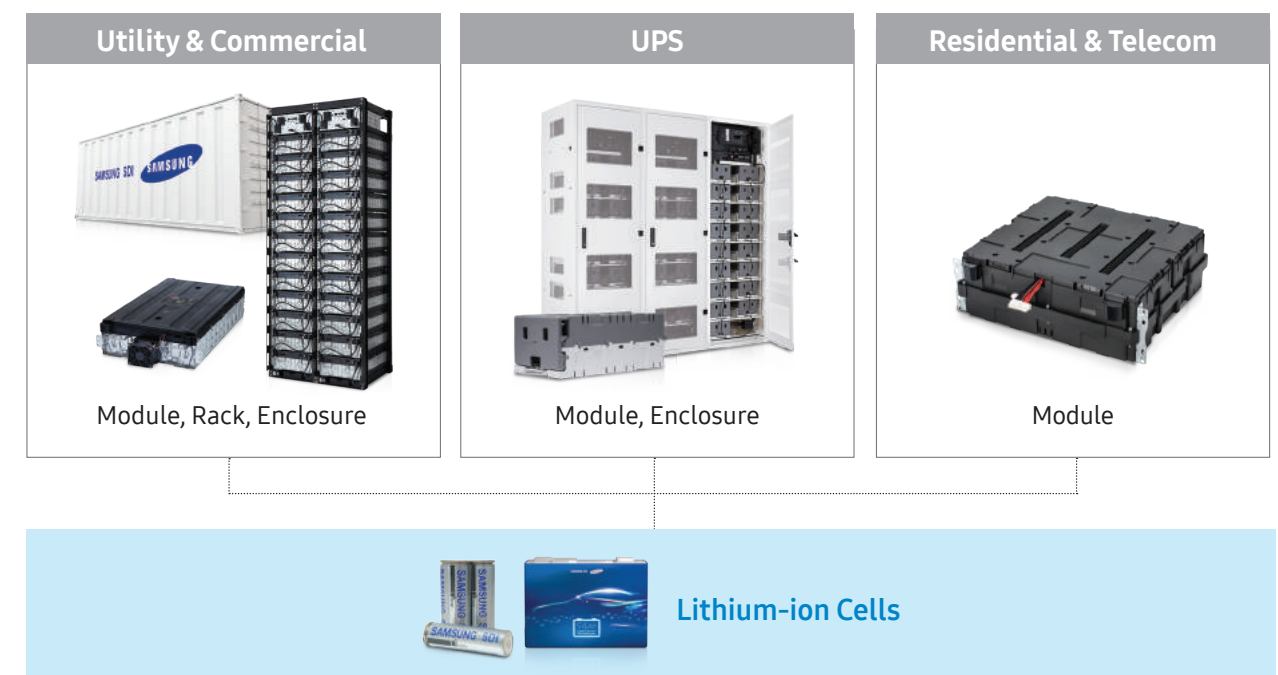

Why Samsung SDI

Samsung SDI designs optimized battery systems through its excellence in cell technology.



Safety First

Multi-layered protection at the cell level resulting in best in class safety.

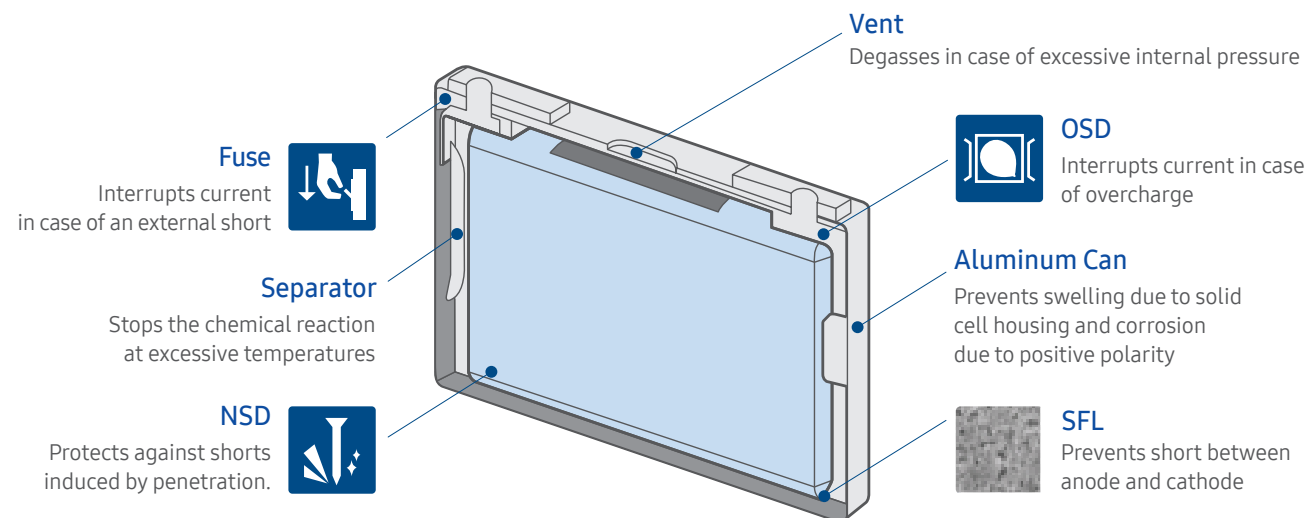

Long Cycle Life

Samsung SDI's prismatic cell has sufficient electrolyte and a stable structure resulting in extended cycle life.

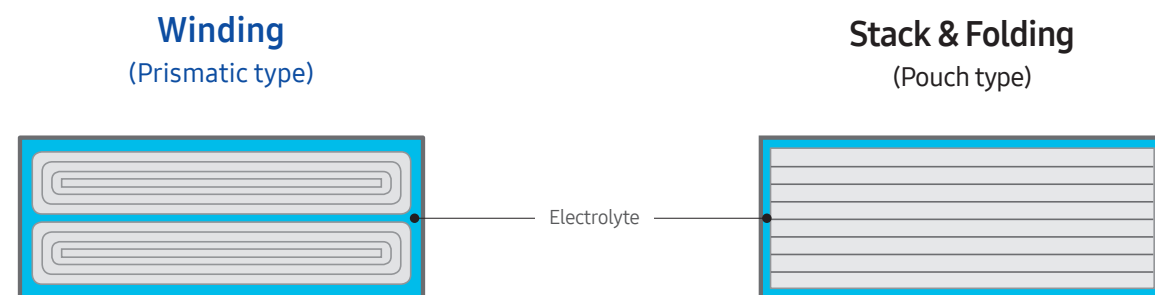

Sustainable Design

Increasing the capacity of the cell while maintaining the same form factor and cell dimensions achieves higher density while retaining battery pack design.

Higher Capacity in Same Form Factor



Higher Capacity without Change in Pack Design

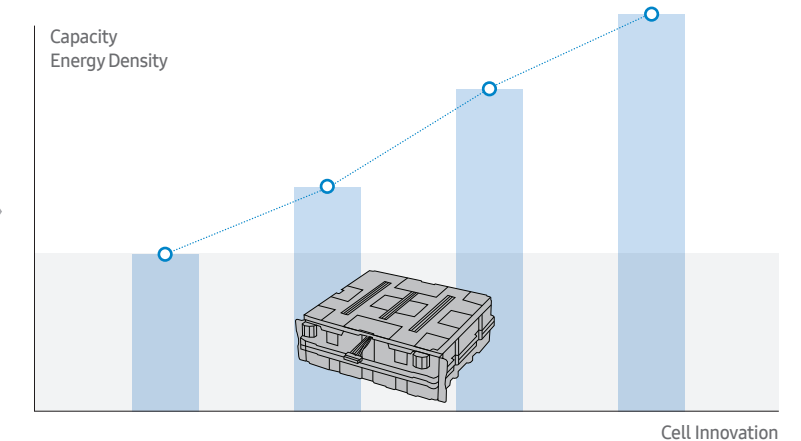

Accurate Lifetime Simulation

Samsung SDI offers optimal battery solutions with its superior lifetime prediction technology.

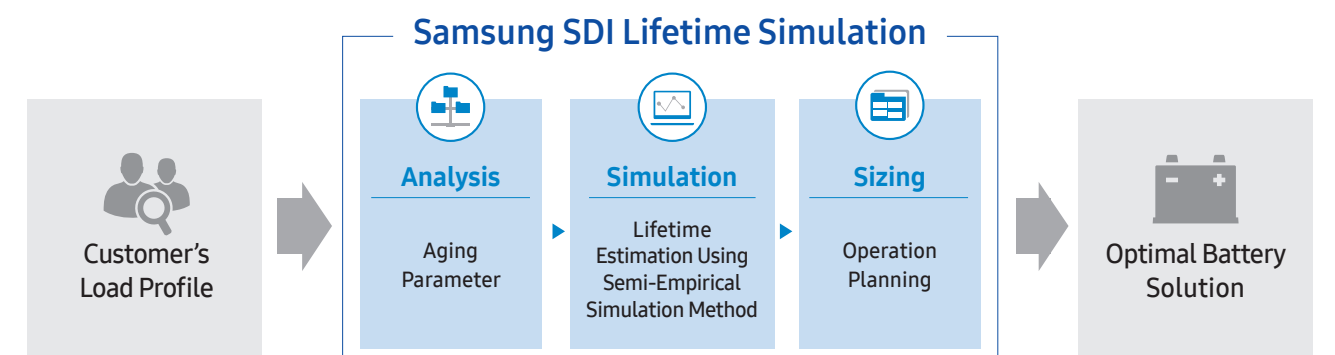

Battery Platform for Utility & Commercial ESS

2017 Innovations

Samsung SDI provides optimized, reliable and innovative battery solutions for ESS applications.

ENERGY



- Innovative module/rack arrangement
- By deploying innovative configurations, a 90%* capacity increase(Max. 9.1MWh) in 40ft enclosure has been achieved.



*Comparison with 2016

POWER



- New cell increases capacity and energy density by 15%
- Increased capacity up to Max.3.9 MWh in 40ft. standard enclosure.

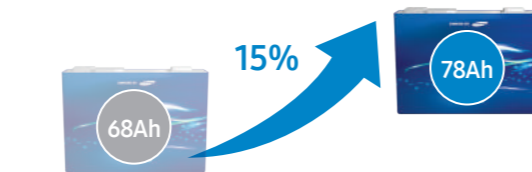

Product Lineup

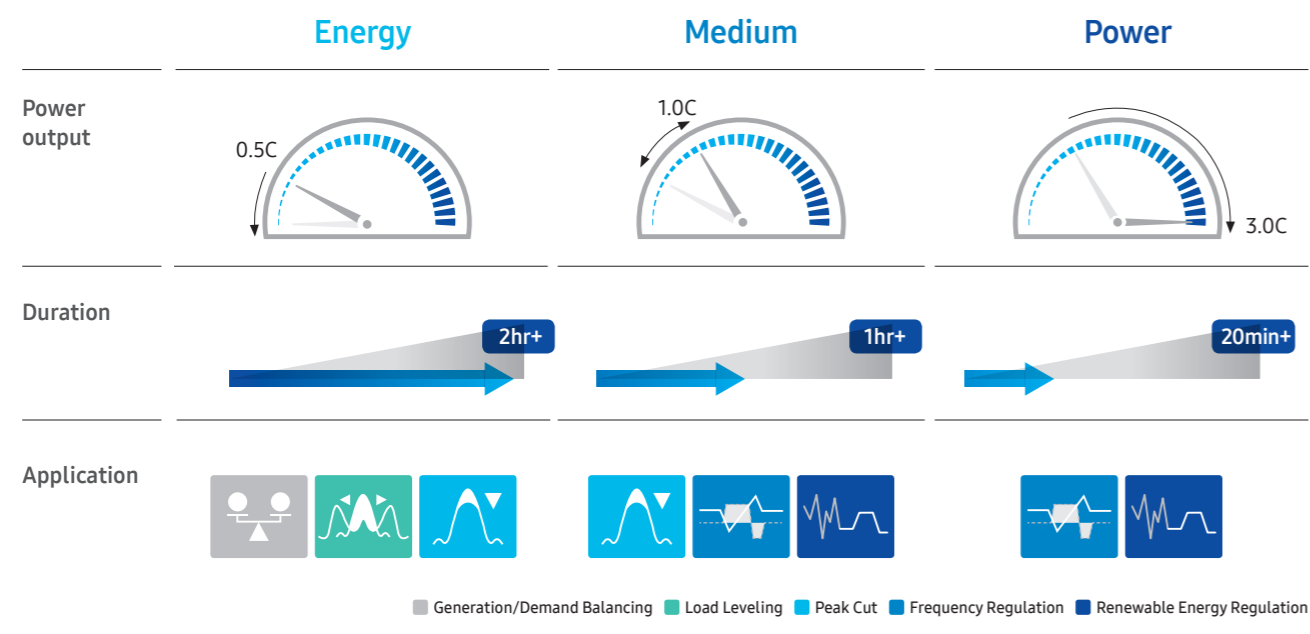

Specifications



Energy

Item		Module		Rack	
Model		E2-M076	E2-R068	E2-R084	E2-R091
Cell Capacity	Ah	94	94	94	94
Energy	kWh	7.6	68	84	91
Operating Voltage	V	70.4~91.3	634~822	774~1,004	845~1,096
Dimension (W x D x H)	mm	370x588x160	442x702x1,792	442x702x2,124	442x702x2,290
Weight	kg	55	550	670	730



Medium

Item		Module		Rack	
Model		M2-M076	M2-R068	M2-R084	M2-R091
Cell Capacity	Ah	94	94	94	94
Energy	kWh	7.6	68	84	91
Operating Voltage	V	70.4~91.3	634~822	774~1,004	845~1,096
Dimension (W x D x H)	mm	370x650x160	442x702x1,792	442x702x2,124	442x702x2,290
Weight	kg	55	550	670	730





Power

Item		Module		Rack	
Model		P3-M063	P3-R056	P3-R070	P3-R075
Cell Capacity	Ah	78	78	78	78
Energy	kWh	6.3	56	70	75
Operating Voltage	V	68.2~90.2	614~812	750~992	818~1,082
Dimension (W x D x H)	mm	370x650x160	442x702x1,792	442x702x2,124	442x702x2,290
Weight	kg	51	520	630	690

Batteries for UPS

Samsung SDI's lithium-ion battery for UPS is capable of supplying a large current (450A) and is compatible with major global UPS companies.

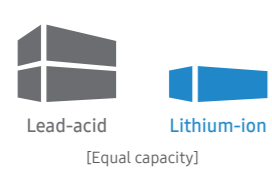
Benefits of Lithium-ion Battery for UPS

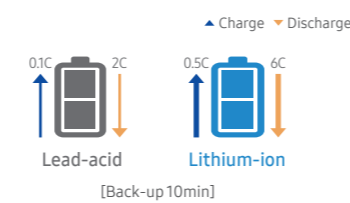
Less Space / Weight	Longer Life	Fast Charge / Discharge Rate
 <p>Lead-acid Lithium-ion [Equal capacity]</p>	 <p>Lead-acid 3~7 years Lithium-ion 15 years</p>	 <p>Lead-acid 0.1C/2C Lithium-ion 0.5C/6C [Back-up 10min]</p>
<ul style="list-style-type: none"> Less space for battery room No structure reinforcement required 	<ul style="list-style-type: none"> Battery replacement deferral Enhanced reliability 	<ul style="list-style-type: none"> No oversizing required Shorter charging time

*This comparison above is based on each material's characteristic

Product Lineup

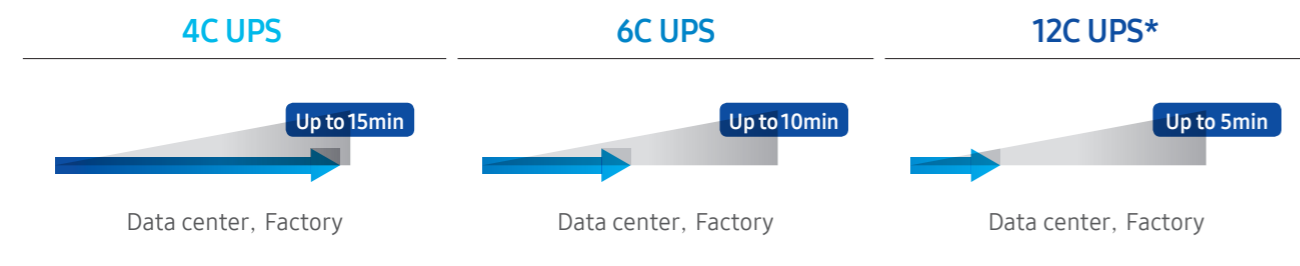

* Available in the second half of year

Specifications

Item	Module			Rack		
	Model	U4-M020	U6-M020	UC-M010	U4-R070	U6-R035
Cell Capacity	Ah	67	67	35	67	67
Energy	kWh	2.0	2.0	1.0	70	35
Operating Voltage	V	24~33.6	24~33.6	24~33.6	408~572	408~572
Dimension (W x D x H)	mm	216x414x163	216x414x163	216x414x163	600x920x1,878	650x600x2,055
Weight	kg	20	20	20	745	550

Batteries for Residential & Telecom

48V Solution

- Advanced lithium-ion battery
- High performance technology for long duration operation
- Compatible with 48V PCS

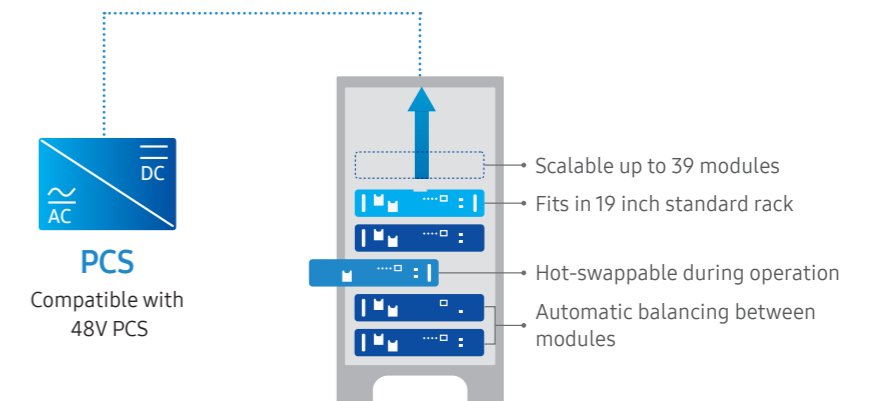

Product Lineup

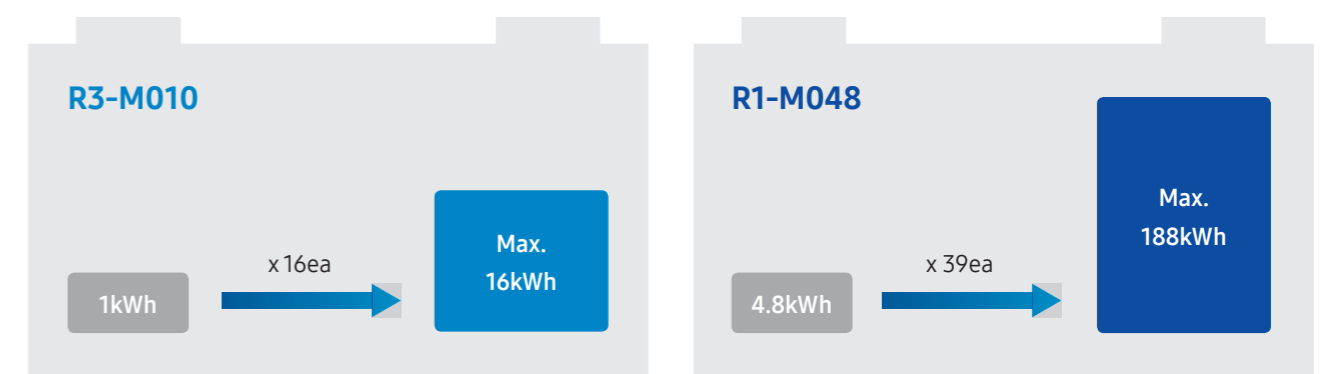

Specifications

Item		R3-M010	R1-M048
Component		Battery Module, BMS	Battery Module, BMS
Energy	kWh	1.0	4.8
Scalability	kWh	16 (16ea)	188 (39ea)
Operating Voltage	V	42~56	44~59
Dimension (W x D x H)	mm	169x377x86	484x450x159
Weight	kg	8	37
Operating Temperature	°C	-10 ~ 60	-10 ~ 50

Global Track Record

Since 2010, more than 1.3GWh of Samsung SDI ESS batteries are being successfully operated in over 30 countries.

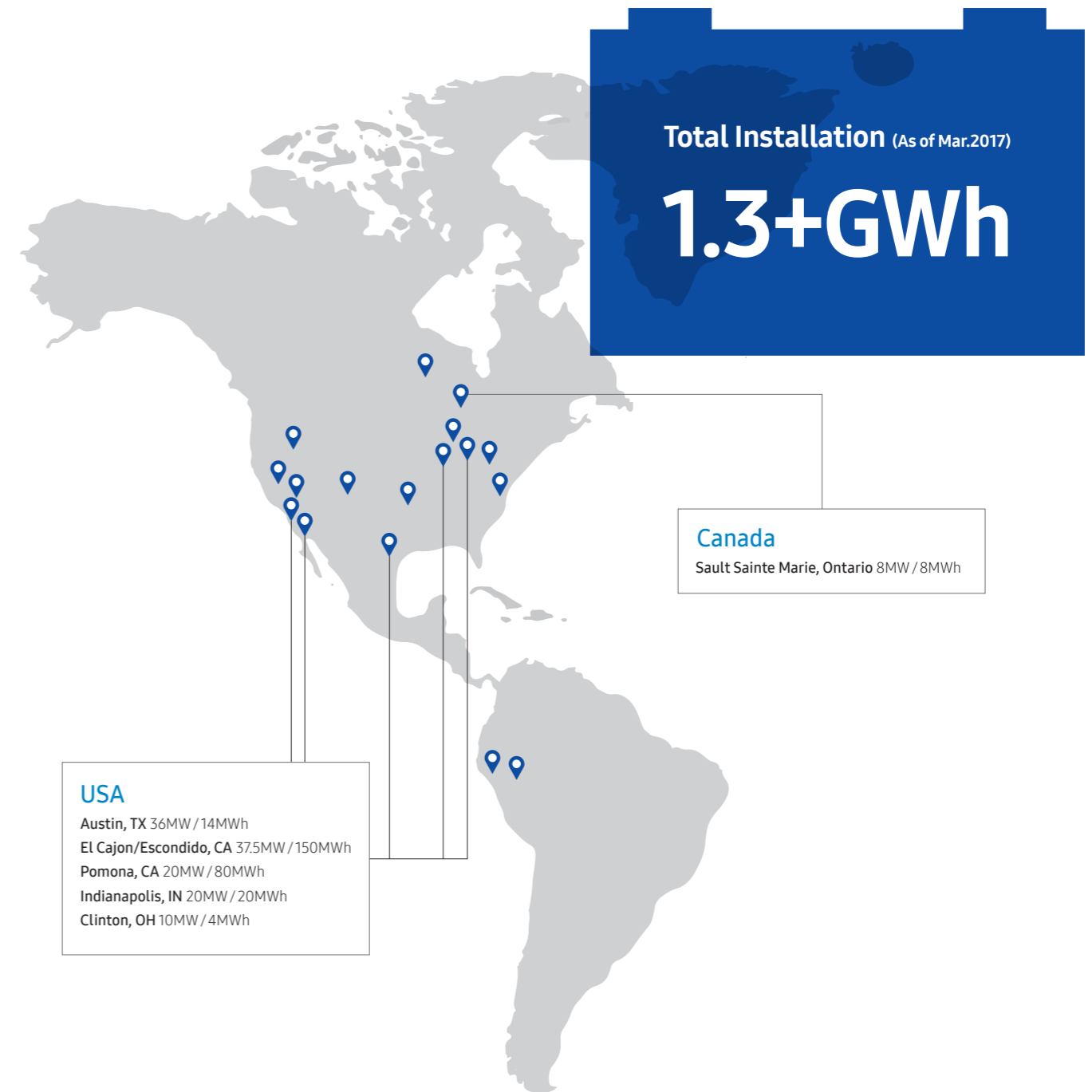

Total Installation (As of Mar.2017)
1.3+GWh

Samsung SDI Leads the Global ESS Market

- Awarded and completed the world's largest ESS project located in the USA (2016)
- Leading the market as the global #1 battery supplier for premium UPS
- #1 Residential ESS battery provider in Japan (2013~)

Australia Austria Cambodia Canada China Czech Denmark France Germany Hong Kong Hungary India Indonesia Israel Italy Japan Kenya Korea Malaysia Maldives Netherlands Philippines Singapore Spain Switzerland Thailand UAE UK USA Vietnam